

TECHNISCHE DATEN

PAVER

BF 200 C-2



Greatest durability



Shorter set-up times



Exemplary efficiency

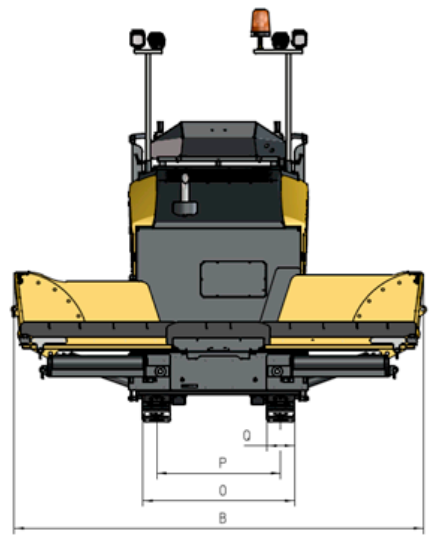
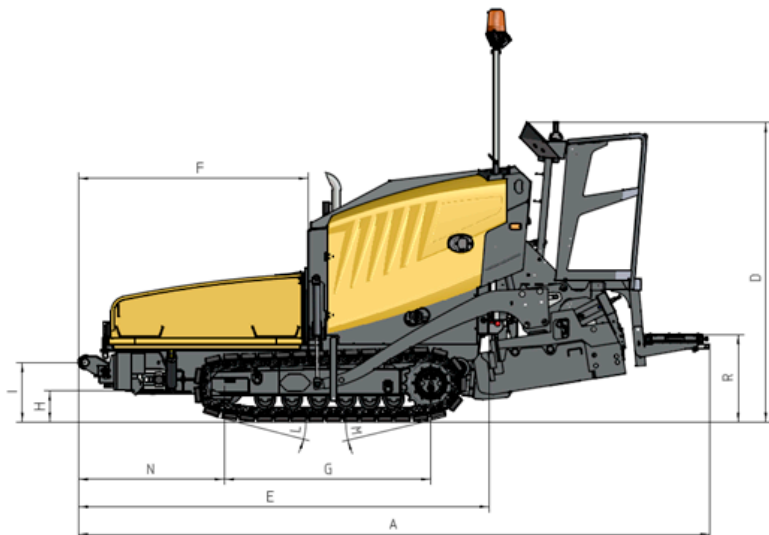

Dimensions in mm

	A	B	D	E	F	G	H	I	L	M	N	O	P	Q	R
BF 200 C-2	4600	2980	1995-2195	2986	1671	1500	228	433	14°	14°	1061	1100	900	200	458-658



Two level platform concept - best view without compromises.



Compact and agile - unique recipe for full flexibility.



Save up to 20 % fuel – demand-driven hydraulics – with BOMAG ECOMODE.



Heats up nearly 60 % quicker – unique MAGMALIFE heating system.

Technical Data

BOMAG BF 200 C-2

Weights

Operating weight CECE kg 6000

Dimensions

Transport length mm 4270

Transport width mm 1300

Transport height mm 1995

Travel characteristics

Travel speed km/h 0-4,5 variable

Working speed m/min 0-29 variable

Drive

Engine manufacturer Kubota

Type V3307-CR

Emission stage Stage V / TIER4f

Cooling liquid

Number of cylinders /Displacement cm³ 4 / 3330

Performance kW / hp 54,6 / 73,2

Speed min⁻¹ 2250

Performance ECOMODE (1.570 min⁻¹) kW / hp 43,3 / 58,9

Performance ECOMODE (1.800 min⁻¹) kW / hp 48,6 / 66,1

Hopper

Capacity m³ 2,0

Width (wings open)..... mm 2980

Width (wings close) mm 1300

Length mm 1400

Filling height (middle) mm 433

Conveyor

Number..... 1

Rotary speed..... m/min 33

Individual control no

Reversing operation Standard

Auger

Number..... 2

Auger diameter mm 300

Rotary speed..... min⁻¹ 87

Reversing operation Standard

Screed

Basic width retracted mm 1100

Basic width extended..... mm 2000

Min. width with reduction skids mm 400

Mat thickness mm 200

Screed plate depth..... mm 250

Screed plate thickness..... mm 10

Heating electric

Crown % -2,0 ... +4,0

Tamper frequency..... Hz max. 30

Vibration frequency Hz max. 60

Basic weight (TV/V) kg 790 / 700

Max. working width..... mm 3400

Filling capacities

Fuel..... l 80

Hydraulic oil..... l 60

Standard Equipment

Operator compartment

- Dashboard protection
- Digital display for machine management
- SIDEVIEW with a double steering and travel joystick

Tractor

- ECOMODE
- Push rollers
- Separate control of hopper wings
- 2 proportionally controlled and reversible wear-resistant cast augers; screw blades separately replaceable
- Rubber track pads

Screed

- Screed temperature control
- Mechanical screed lock
- Crown adjustment
- Side control of auger/scrapper belts

Other

- Tools
- Three phase Generator

Hopper

- Viewing tunnel

Optional Equipment

Operator compartment

- Two platform concept

Tractor

- Integrated cleaning kit
- Asphalt steam extraction
- Optional paint finish
- Biologically degradable hydraulic oil
- Hydraulic, height adjustable auger
- Track scraper
- Direction rod
- Ultrasonic sensors for auger control

Screed

- Hydraulic crown adjustment
- S 200 extensions: 350 mm
- S 200 extensions: 600 mm
- MAGMALIFE Aluminium heating plates
- Heated side plates
- Reduction shoes

Levelling systems

- L.C.S. Screed relief and traction increase system
- Height and cross-slope sensing by means of ultrasonic or mechanical sensors

Other

- Fleetmanagement BOMAG TELEMATIC
- LED working lights
- Sunroof
- Joblink data interface

Hopper

- Hydraulic side flap

