



# MILLIONS OF KILOMETRES BEAR OUR SIGNATURE.

You build the finest roads so we can all move forward faster. And to ensure that you can progress faster, we build the best machines.

As a member of the leading international FAYAT group, we supply machines for all areas of road construction – from soil compactors to cold planers and recyclers, from asphalt rollers to road pavers. For over 60 years, the history of our company has been synonymous with the history of road construction.

With our accumulated know-how, we are an innovation driver that sets the pace for an entire industry. BOMAG has developed a huge number of technologies, from systems for measuring and controlling compaction, such as ECONOMIZER and ASPHALT MANAGER, to technologies for reducing operating costs, such as ECOMODE and the most effective screed heating in the market:

MAGMALIFE. We offer solutions for a wide range of applications.

Our global network of experts and partners in over 120 countries is there to support you, from the configuration of the machines to providing solutions for the most challenging of tasks.

We owe our innovative strength to our more than 2,500 employees worldwide, their commitment and their unique wealth of experience. A source of know-how which has propelled us to worldwide market leadership in this sector. The reason for this is our unconditional commitment to quality: in product development and production, in the qualification of our employees, and in a service that guarantees optimal on-site support.







## WE ENHANCE YOUR PRODUCTIVITY.

### **ASPHALT COMPACTION DEMANDS THE SKILLS OF BOMAG SPECIALISTS.**

We have been developing, designing and building compaction equipment for almost 60 years. Our engineers are dedicated to making every new generation of machines even better, more cost-effective and more productive than the previous one. And they always have one goal in mind: every BOMAG machine must work more efficiently, more conveniently and more professionally.

We keep in close contact with our customers, to help us find solutions that deliver tangible increases in productivity and allow you to complete your projects productively and precisely to specification.

BOMAG was the first manufacturer to launch a pneumatic tyred roller which combines conventional compaction with a state-of-the-art hydrostatic drive, making it ideally suited for use in both earthworks and asphalt construction applications.



At an operating weight of 8.6 t or more, the BOMAG BW 28 RH pneumatic tyred roller is your first choice for many applications. Whether with ROPS or with cab: maximum productivity as well as comfortable and convenient operation are always ensured.

The roller can be adapted to any compaction task at hand and excels not only in terms of power and efficiency: safety as well as comfortable and convenient operation are additional priorities here at BOMAG.

You can depend on the expertise of our engineers and on the high level of service provided by our sales network. You can rely on legendary BOMAG quality. Because at BOMAG we have one key goal: to enhance your productivity.



# MORE POWER, MORE ADDED VALUE.

## BOMAG EASY SERVICE.

- All service points can be reached from the ground
- Easy filling of tanks
- Extensive diagnostics options

## FLEXIBLE WEIGHT ADJUSTMENT.

- Large ballast compartment
- Quickly changeable steel/concrete weights
- Water ballast as an option

## POWERFUL PERFORMANCE.

- BOMAG ECOMODE
- Three-way pivoting front axle
- Load limiter controller





### **UNOBSTRUCTED VIEW.**

- Modern, new frame design for an outstanding view to the top of the wheels
- Clear view of the outer edges of the tyres
- Outstanding 360° view

### **MAXIMUM COMFORT LEVELS AND EASE OF OPERATION.**

- Spacious ROPS cab
- Easily rotatable and slidable driver's seat
- Highly responsive travel control
- New type of "rocker brake" with the same width as the driver's stand

### **SUPERIOR SURFACE QUALITY.**

- Better weight distribution across the tyres
- Compaction closer to the track edge allows for an optimum view of the outer edges of the tyres

# KEEPING AN EYE ON THE AREAS THAT MATTER MOST

*The best compaction quality can only be achieved if you have an optimum view of the roller's operating area. This is why the BW 28 RH comes with unobstructed views across all key areas.*

## **UNIQUE FRAME DESIGN.**

The best examples can often be found in the natural world. An outstanding feature of this BOMAG pneumatic tyred roller, for instance, is its hammerhead shark frame design. The front section of the roller was modelled after the distinctive head of this famous predatory fish. This shape offers the roller driver a clear view of the top of the wheels, to check whether the wheels are sufficiently wet to avoid bitumen sticking.

## **NO BLIND SPOTS.**

The BW 28 RH also guarantees an optimum view of the outer edges of the tyres to help with precise roller orientation, made possible by cab doors that open in opposite directions. Nothing obstructs the view to this all-important area: yet another advantage of providing better safety and quality.

## **OUTSTANDING 360° VIEW.**

It is primarily the new frame design which accounts for the improved 360° view. The large all-glass surface area of the cab creates an interior that is neat and bright. The frame outline of the BW 28 RH as well as the cab and ROPS structure optimised for an improved viewing experience offer an optimum 360° view of the area around the machine. The arm rest can be extended out of the window, giving the driver an optimum view of the tyres.

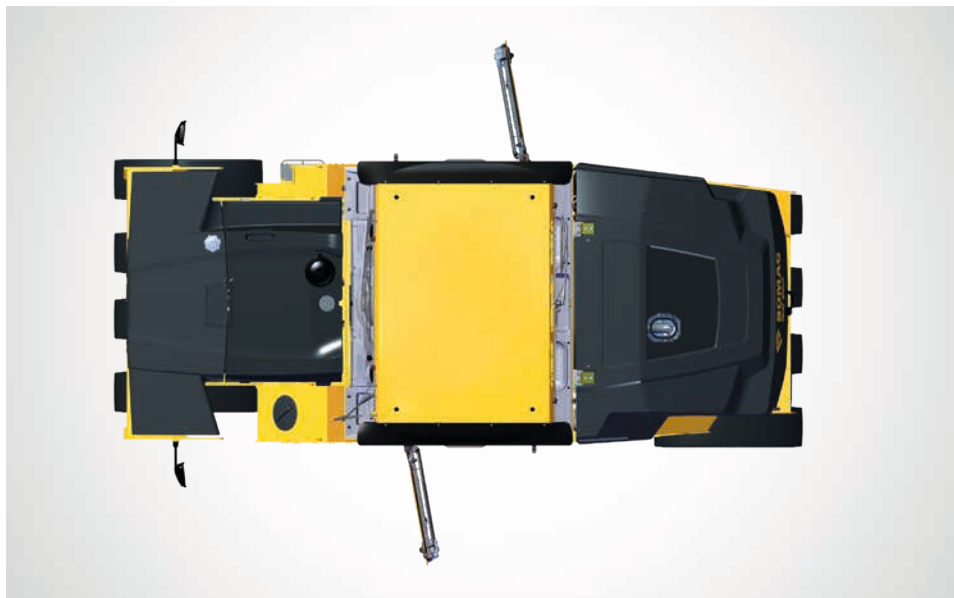





T.

The BW 28 RH offers an excellent view of the working area in front and behind the roller, as well as to both sides of the machine. This provides added safety and ensures the best work results.

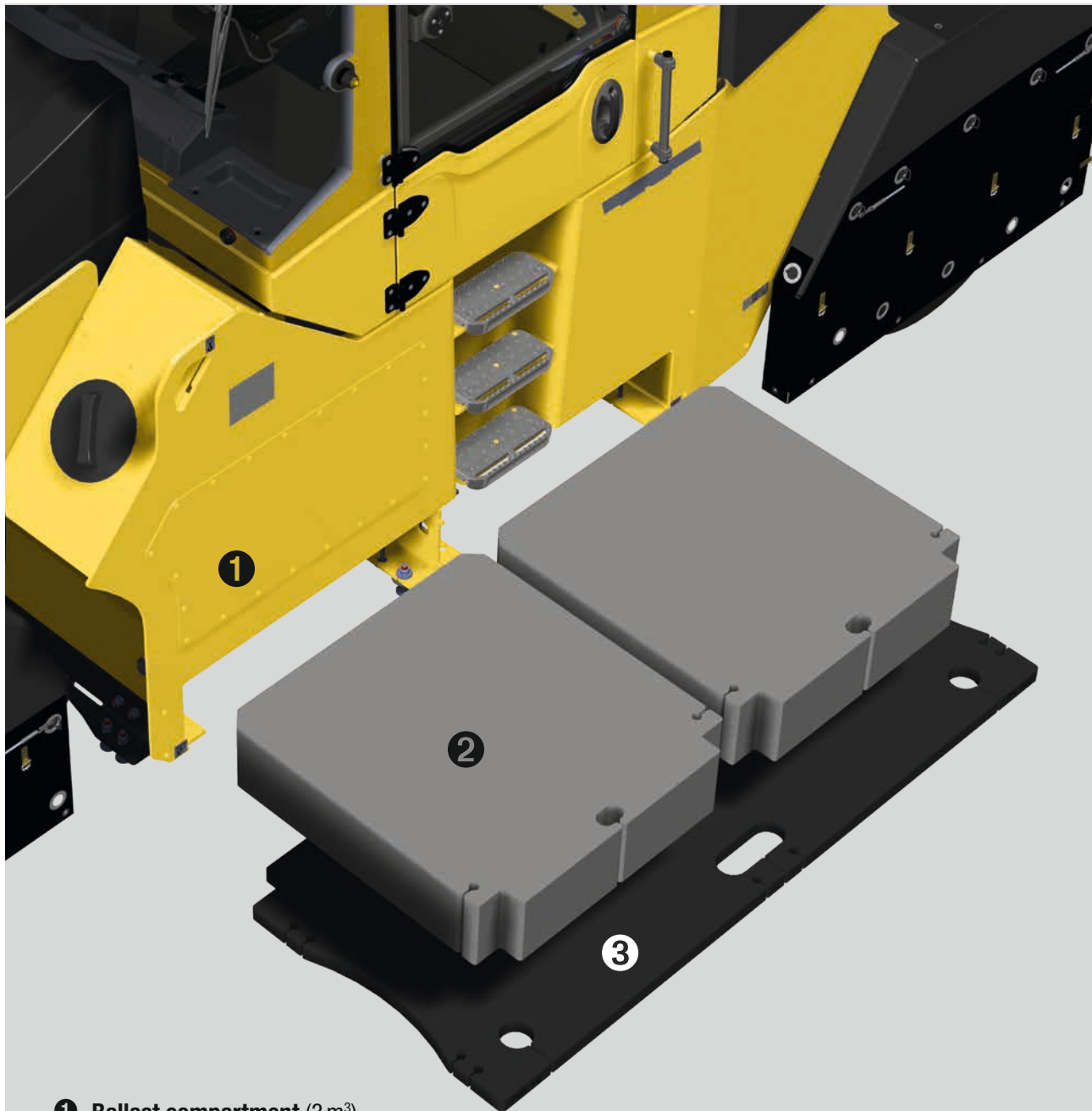

- ❶ Ballast compartment (3 m<sup>3</sup>)
- ❷ Concrete weights (4 x 750 kg) or Steel weights (4 x 1,500 kg)
- ❸ Underfloor weights (2 x 700 kg)

Ballast compartment	
Water	+3,000 kg
Dry sand	+4,500 kg
Wet sand	+6,000 kg

With the flexible option of adding additional ballast, the basic weight of this pneumatic tyred model can be adapted to the job at hand, resulting in optimum compaction.

# HEAVYWEIGHT WHEN NEEDED.

The BOMAG BW 28 RH is a machine suitable for a wide variety of applications. The pneumatic tyred roller's ballasting options make it multi-talented on any construction site.

## QUICK AND FLEXIBLE WEIGHT ADJUSTMENT.

Now that's what we call flexible: with the BW 28 RH you first compact the bearing course and then the binder course and/or wearing course. Or perhaps you work across different construction sites with different requirements where you can employ this machine. It is only a question of weight – which, with our new BOMAG pneumatic tyred roller, you can easily adapt to local conditions on-site.

## CUSTOM BALLASTING.

Ex works, the BW 28 RH is available with finely tuned operating weights from 8.6 to 28 t. Using steel and concrete weights that easily slide in or out, you can adjust the roller's operating weight to the work at hand in a matter of minutes. In addition, you can use the 3 m<sup>3</sup> ballast compartment for any custom ballasting needs.

28 t
24 t
20 t
18 t
16 t
12 t
10 t
8.6 t

Handy ballast compartment

Operating weight	Wheel load
28,000 kg	3,500 kg
24,000 kg	3,000 kg
20,000 kg	2,500 kg
18,000 kg	2,250 kg
16,000 kg	2,000 kg
12,000 kg	1,500 kg
10,000 kg	1,250 kg
8,600 kg	1,075 kg

Technical modifications reserved. Machines may be shown with options.

# CUTTING COSTS.

*The BW 28 RH demonstrates its strengths wherever impressive performance is expected and required. With this pneumatic tyred roller, you not only increase efficiency and productivity on construction sites, particularly in road construction, but also overall cost-effectiveness.*

## SMART CONTROL SYSTEM – SAVES MONEY.

BOMAG ECOMODE controls and regulates the engine using a load-dependent concept giving the precise speed required for the power needed at any time. The load-dependent engine speed control system saves up 30% in fuel. And because the machine now runs more quietly due to its reduced engine speed, both the driver and the environment also benefit.

## THE PERFECT SPRAY.

The tyres of a roller need to be wet but not over wet, and very little water is needed once they are warm. With the BW 28 RH, you have the choice of six spraying intervals. A quick glance at the tyre surface should be sufficient to decide whether more or less water is needed.



## POWER FOR GRADIENT WORK.

The load limiter controller of the travel control system ensures that the roller's engine is used to optimum capacity at all times. As a result, the drive cannot be overloaded and (consequently) stalled under a heavy load such as on challenging inclines.

## ADAPTATING TO UNEVEN SURFACES.

The three-way pivoting front axle of the BW 28 RH ensures even weight distribution across all tyres.

## THE RIGHT CONTACT PRESSURE, ALWAYS.

The success of a compaction job largely depends on the right contact pressure. Using the optionally available automatic tyre inflation system, you can quickly adapt tyre pressure to the job at hand. Tyre pressure can be varied between 2 and 8 bar, and can be kept at a constant automatically. The variable tyre pressure ensures uniform contact of the tyres with the ground.

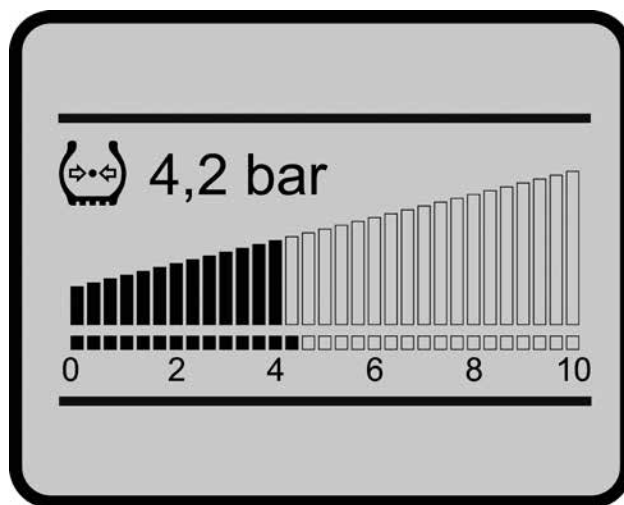

This is another particularly ingenious feature that puts the BW 28 RH pneumatic tyred roller in a class of its own. As a result, this model offers outstanding performance, no matter the local conditions.

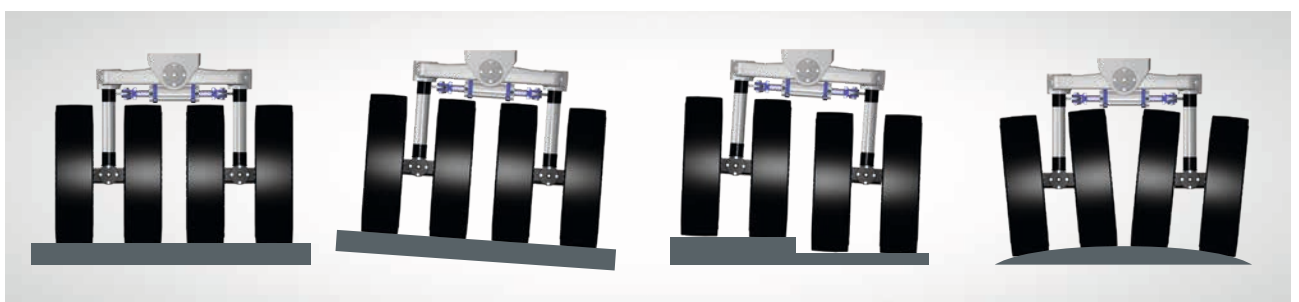

# THE PERFECT PLACE TO WORK.

*The cab of a roller becomes a driver's "office" during the day. With the BW 28 RH, BOMAG has made sure that the driver enjoys optimal ergonomics and the best in comfort, safety and convenience – because easy operation and high levels of driving comfort don't just make a driver's job easier: work also becomes far more productive.*

## **SPACIOUS DELUXE CAB.**

The BW 28 RH roller's generously sized cab offers everything a driver needs in terms of a pleasant and productive work environment: freedom of movement, plenty of storage options and a high-performance heating and ventilation system in the case of the cab-mounted model. And thanks to the fully sealed floor of the driver's position, the cab also offers good sound-proofing.



## **FAMILIAR BOMAG CONCEPT OF OPERATION.**

The BOMAG concept of operation, which is also employed in this new pneumatic tyred roller, now covers the entire BOMAG product portfolio. Drivers feel at home right away, and can start using the machine safely and with confidence right from the outset. Switches and displays are in the same, familiar position, eliminating lengthy periods of adaptation. The machine is ready for operation immediately.

## **ENJOY FLEXIBLE AND COMFORTABLE SEATS.**

Once the driver sits down in his fully adjustable driver's seat, he is ready for even the most demanding working shifts. With the seat being freely rotatable in the direction of the steering column, he can sit in a variety of positions, allowing adjustment of the position towards the steering wheel during a long day at work. The re-designed brake pedal takes up the entire width of the driver's stand, making it safely and directly accessible at all times.



Conventional pedals are no longer included, increasing both the viewing scope for the driver and the movability of his seat.



The BW 28 RH roller offers everything you expect in a modern work place: easily accessible, extremely spacious, and with all the controls in just the right position.



#### **REAL-LIFE ERGONOMICS.**

The new pneumatic tyred roller also sports BOMAG's tried and tested multi-function arm rest, whereby the actual arm rest is connected to the movement of the joystick. Driver's seat, joystick and steering wheel were placed in position using state-of-the-art ergonomics tools and are located in the optimum position. Thanks to the generously sized access steps and a floor that is free of clutter, the driver reaches his work place in comfort and safety. The compact steering wheel allows convenient access to the driver's seat, without the effort of having to fold up the consoles. Safety is part and parcel of the BW 28 RH, thanks to its rocker brake: The large brake pedal, which is safely accessible at all times, allows not only for a smooth brake action (such as on inclines), but also for an emergency brake procedure with extremely short stopping distances.

For the workplace to literally stay clean, BOMAG offers powerful solutions that prevent asphalt from sticking to these pneumatic rollers.





# NO MORE ASPHALT STICKING.

*There are two reasons why asphalt shouldn't be sticking to a roller's wheels: Firstly, the integrity of the asphalt surface layer might be compromised; and secondly, the tyres might suffer damage and need to be replaced. Both issues cost time and money.*

## **OPTIMUM WATER DISTRIBUTION.**

The BW 28 RH comes with one spray nozzle per tyre as standard, which sprays the entire width of the tyre. The adjustable scrapers are easy to access and easy to clean.

## **IMPROVED WATER DISTRIBUTION.**

The optional natural coco mat or brush ensures improved distribution of the spray. Water is evenly distributed over the entire surface of the tyres, making sure that all wheels receive an even spray. At the same time, any material is brushed off the tyres, thereby preventing build-up.

## **UNIFORM TYRE TEMPERATURES.**

Thermal aprons are available as an option for the BW 28 RH. Heat shields help to warm up the tyres quicker, thereby maintaining evenly high tyre temperatures. Asphalt pick-up, which may damage the surface, is effectively prevented. And, thanks to the roller's innovative design and extremely compact construction, the driver always maintains an optimum overview of his working area.



# SERVICE, THE EASY WAY.

*There are no extended waiting periods with the BW 28 RH, something to be taken quite literally with this pneumatic tyred roller. Because thanks to BOMAG Easy Service, you can carry out all maintenance work in next to no time at all. Plus, you can rely on proven BOMAG quality of service backed up with original parts to ensure your machine's efficiency over the long-term.*

## **QUICK AND EASY MAINTENANCE.**

The one-piece engine hood can be easily and fully opened by hand, ensuring that all service points on the engine are easily and conveniently accessible from the ground. The water and diesel tanks are also easily accessible. Again, you save valuable time because these tanks can be filled very quickly.

## **PROVEN BOMAG RELIABILITY.**

Efficient service coupled with high availability of original parts are included whenever you purchase any BOMAG machine. We are your reliable global partner, with twelve subsidiaries abroad and over 500 dealers in more than 120 countries. No matter where your machine is running: we will not let you down!

## **NO HALF MEASURES!**

When you choose a BOMAG machine, you choose peace of mind – especially when it comes to service. BOMAG service means fast, reliable, on-site support. We know our machines inside and out, we have all original parts in stock and we will always find a solution to your problem. No experiments. No false pretences. We know what we're doing! Saving you time, money and stress.

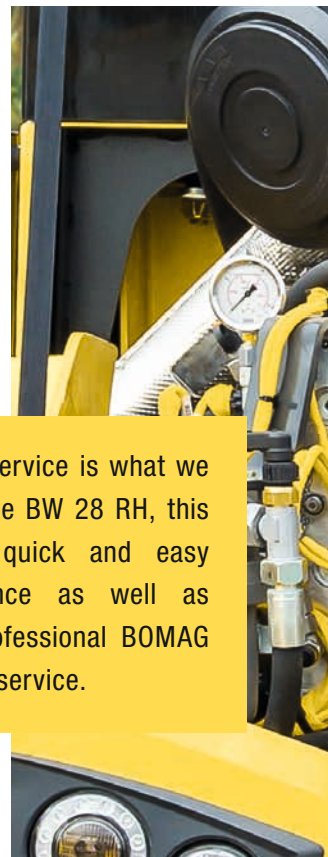

Friendly service is what we do. For the BW 28 RH, this includes quick and easy maintenance as well as highly professional BOMAG technical service.

### **EXTENSIVE DIAGNOSTICS.**

The BW 28 RH offers a host of diagnostics options. To carry out on-board diagnostics, the multi-function display inside the cab provides a wide range of error and fault detection as well as service information (including the exact name of the component). In addition, the machine also offers an off-board diagnostics interface, which can be used to connect the BOMAG Diagnostic Kit. This allows each of the control units of the machine to be read out and additional detailed fault descriptions to be accessed.



### **NO STICKING ASPHALT!**

The BOMAG bitumen separating agent is vegetable oil-based and features good separating properties for mastic asphalt and hot rolled asphalt applications, and is particularly suitable for use with pneumatic tyred rollers. The concentrated emulsion is water-soluble and can be added to water at a ratio of 1:10, making it highly cost-effective to use. And thanks to its good biodegradability in water and in soil, the BOMAG bitumen separating agent can be used on all construction sites, especially on sites located next to water catchment areas and water conservation areas.

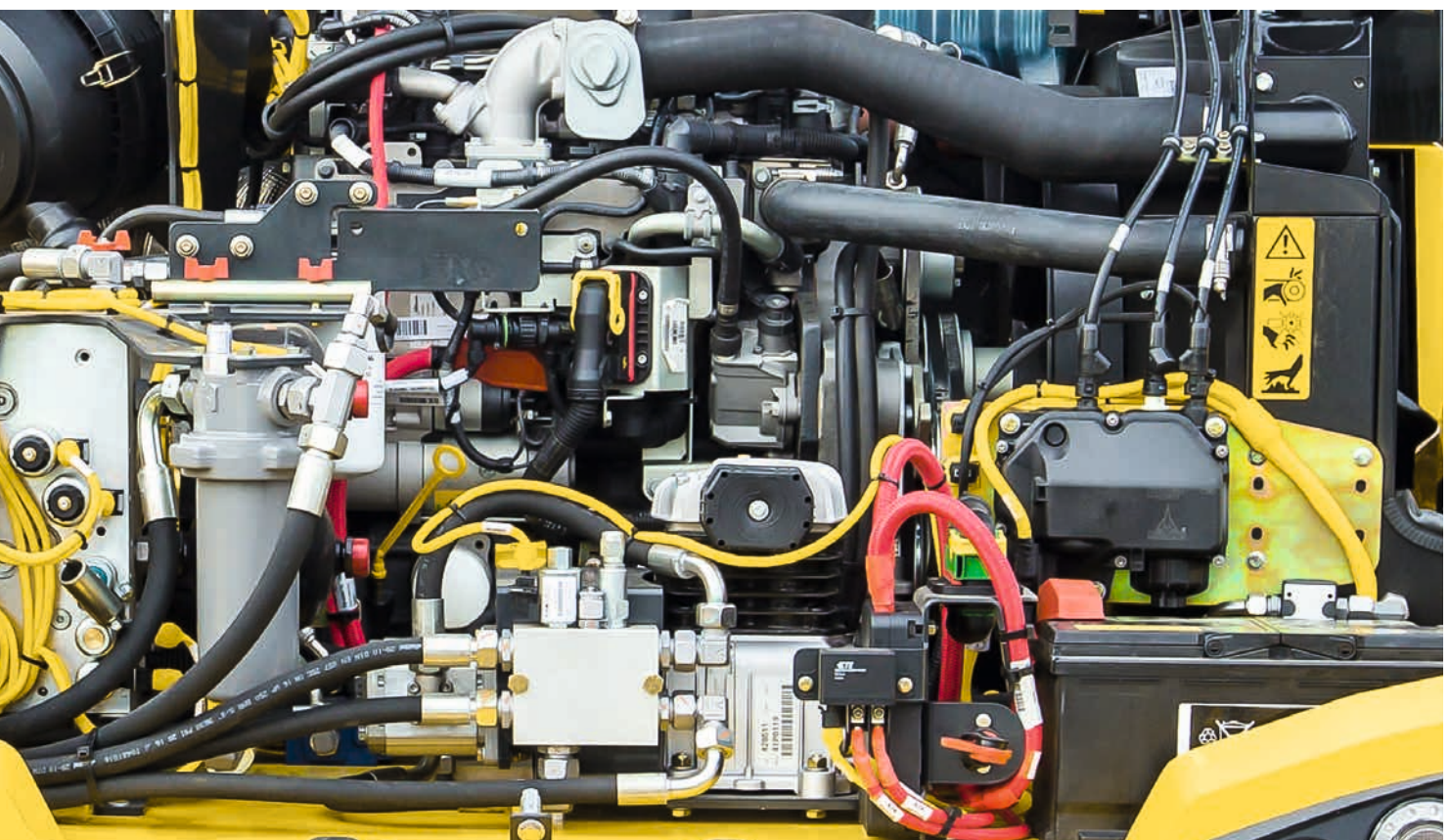

# TOTAL ADAPTABILITY.

*With a comprehensive range of accessories, the BW 28 RH roller easily adapts to your individual requirements.*

## **CUSTOM TYRE PRESSURE.**

The automatic tyre inflation system adjusts tyre pressure to pre-definable values of between 2 and 8 bar, a useful option when varying operating weights require different levels of tyre pressure. All you need do is set the pressure you need, and the tyre is adapted automatically.

## **AUTOMATICALLY PROPORTIONED EMULSION.**

Some asphalt mixes require extra emulsion in addition to the water spray to prevent the asphalt from sticking to “cold” roller tyres. Our emulsion spraying system ensures that the emulsion is automatically proportioned and injected into the spraying water using a pre-selected mixing ratio.

The accessory options for BOMAG's new pneumatic tyred roller are designed to perfectly fit your machine, making sure all runs smoothly and as expected.



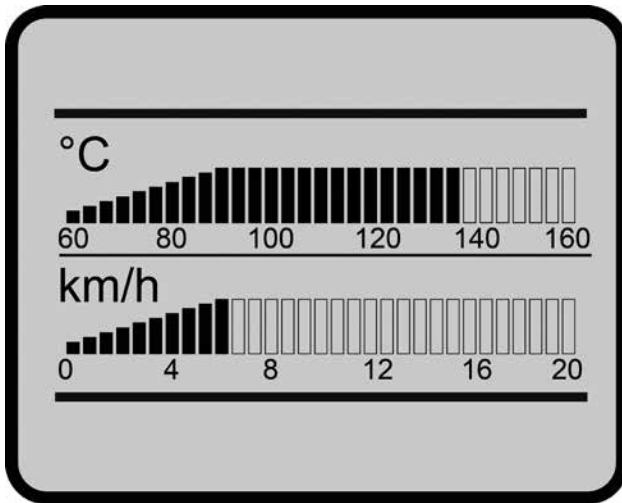

**KEEPING AN EYE ON ASPHALT TEMPERATURE.**

With the asphalt temperature sensor, you never lose sight of the asphalt mat temperature and always know whether the material is too hot or too cold. This prevents unwanted rolling problems. The operator keeps the roller in the area where the material has the right rolling temperature and does not waste time trying to compact material that is too cold.

**TURNING NIGHT INTO DAY.**

Construction sites require operators to work at night, especially when deadlines are tight, or during the autumn and winter season. The optional side lights of the BW 28 RH ensure that you will not miss a thing along the sides, even in the dark. The rear view camera is another optional accessory that lets you keep an eye out all round.



# MADE FOR TOUGH AND VARIED APPLICATIONS.

*The BW 28 RH multi-talent roller is made for challenging applications in road construction. For motorways, country roads, urban roads, airport runways or parking lots: thanks to extreme flexibility due to its highly specialised product design, the BW 28 RH takes every new site specification in its stride.*

With kneading and flexing effects, pneumatic tyred rollers achieve an outstanding level of quality in static compaction. Producing a uniform distribution of the mix which seals the surface voids well. The main areas of application are pre-profiling and processing of easy-to-compact mixes, and the surface sealing of wearing and bearing courses or of base/surface courses. For this work, a pneumatic tyred roller is typically combined with a smooth drum roller.

The compaction effect is achieved by the dead weight of the machine and the kneading and flexing effect of the wheels. The tyre inflation pressure affects the efficiency of compaction (e.g. the number of passes).

## APPLICATION

- Surface treatments
- Pre-compaction of sensitive asphalt layers
- Surface sealing of wearing courses

## COMPACTION EFFECT

- Kneading effect and ground contact pressure

## IMPORTANT EQUIPMENT FEATURES

- Wheel load
- Inner tyre pressure







## MODEL OVERVIEW.

*BW 28 RH, the new BOMAG pneumatic tyred roller generation in the 8.6 to 28 t performance class, offers highly cost-effective performance on earthworks and asphalt construction applications, for compacting stabilised soil layers, and for rolling chippings on surface treatment work.*







Model	Version	Operating weight [kg]	Wheel load [kg]	Working width [mm]	Power [kW]
BW 28 RH	Stage IIIa / TIER 3	8,600 – 28,000	1,075 – 3,500	2,042	92
BW 28 RH	Stage IV / TIER 4f	8,600 – 28,000	1,075 – 3,500	2,042	100

Technical modifications reserved. Machines may be shown with options.



**BOMAG**  
FRONT GROUP

**BW28 RH**

# PERFECTION BY DESIGN.

BOMAG know-how is invested in every roller. Down to the last detail. Helping you leverage your own experience and expertise. The result is a winning partnership. Every time.



Head Office:

**BOMAG**  
Hellerwald  
56154 Boppard  
GERMANY  
Tel. +49 6742 100-0  
info@bomag.com

**BOMAG Maschinen-  
handels-gesellschaft m.b.H.**

Klausenweg 654  
2534 Alland  
AUSTRIA  
Tel. +43 2258 20202  
austria@bomag.com

**BOMAG MARINI EQUIPAMENTOS LTDA.**

Avenida Clemente Cifali, 530  
Distrito Industrial Ritter  
Cachoeirinha – RS  
BRAZIL  
ZIP code 94935-225  
Tel. +55 51 2125-6642  
brasil@bomag.com

**BOMAG (CANADA), INC.**

2233 Argentia Road, East Tower  
Suites 302  
L5N 2X7 Mississauga, ON  
CANADA  
Tel. +1 800 782 6624  
canada@bomag.com

**BOMAG (CHANGZHOU)**

Construction Machinery Co., Ltd.  
No. 66 Bopa Road  
Xuejia Town  
Xinbei District  
Changzhou 213125  
CHINA  
Tel: +86 519 88585566  
china@bomag.com

**BOMAG India Pvt Ltd**

Unit No. 614, B Wing, 6th Floor  
Kanakia Wall Street  
Chakala Andheri Kurla Road Andheri East  
Mumbai 400 093 Maharashtra  
INDIA  
Tel.: +91 8657492418  
india@bomag.com

**BOMAG France S.A.S.**

2, Avenue du Général de Gaulle  
91170 Viry-Châtillon  
FRANCE  
Tel. +33 1 69578600  
france@bomag.com

**BOMAG (GREAT BRITAIN), LTD.**

Sheldon Way  
Larkfield, Aylesford  
Kent ME20 6SE  
GREAT BRITAIN  
Tel. +44 1622 716611  
gb@bomag.com

**BOMAG Italia**

Via Roma 50  
48011 Alfonsine  
ITALY  
Tel. +39 0544 864235  
italy@bomag.com

**FAYAT BOMAG Polska Sp. z o.o.**

Ul. Szyszkowa 52  
02-285 Warszawa  
POLAND  
Tel. +48 22 482 04 00  
poland@bomag.com

**FAYAT BOMAG RUS OOO**

141400, RF, Moscow region  
Khimki, Klayazma block, h. 1-g  
RUSSIA  
Tel. +7 (495) 287 92 90  
russia@bomag.com

**BOMAG GmbH**

300 Beach Road  
The Concourse, #18-06  
Singapore 199555  
SINGAPORE  
Tel. +65 6 294 1277  
singapore@bomag.com

**BOMAG Americas, Inc.**

125 Blue Granite Parkway  
Ridgeway SC 29130  
U.S.A.  
Tel. +1 803 3370700  
usa@bomag.com

